

EHPM 400 MINI MONOFASE
EHM 400 MINI MONOFASE

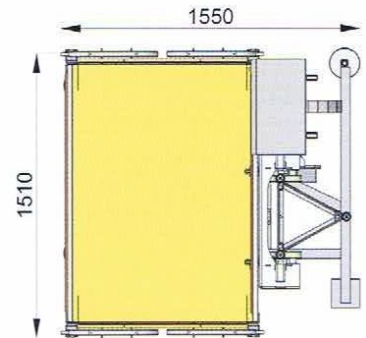
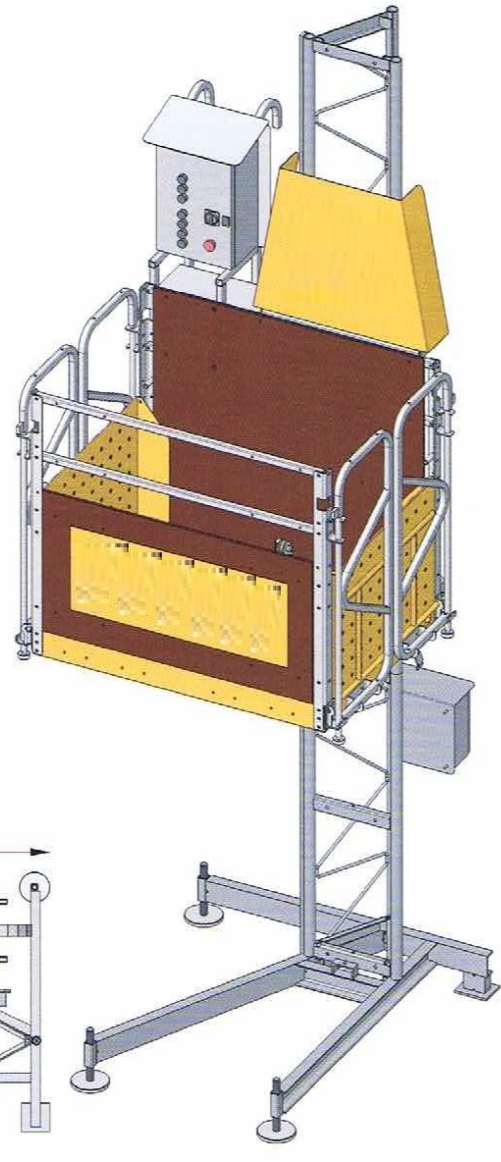
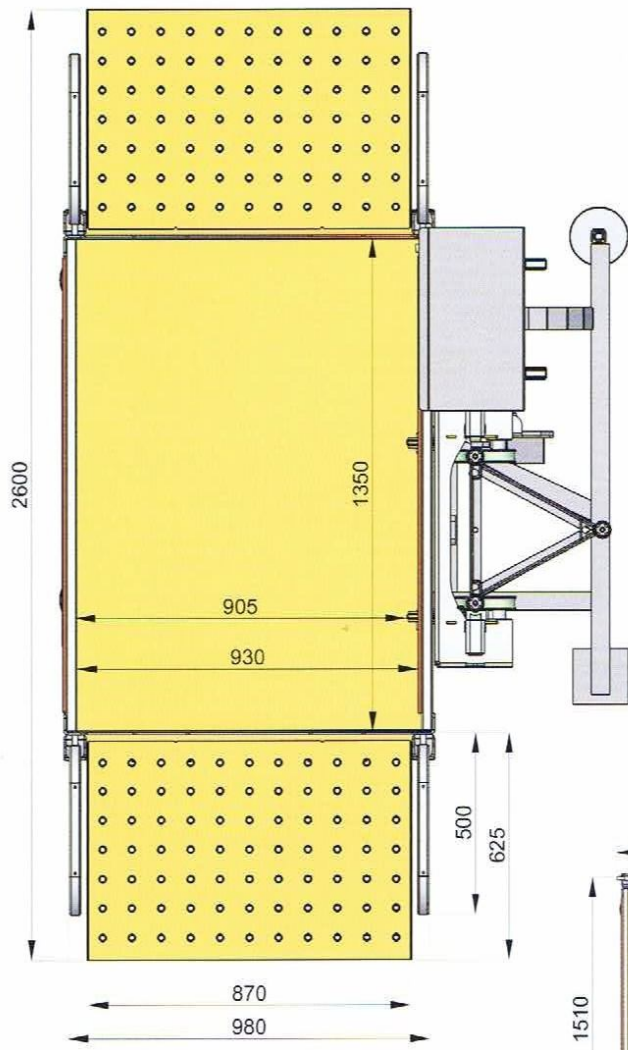

	400 kg	EHM
↑	+300 kg	EHPM
↑↑	+200 kg	
↑↑↑	+100 kg	
↑↑↑↑	+0kg	

PIATTAFORMA DI TRASPORTO / MONTACARICHI
TRANSPORT PLATFORM / MATERIAL HOIST

Dati tecnici	Technical Data	Données Techniques	Datos Tecnicos	EHPM / EHM 400 MINI monofase
Capacità di carico	Capacity	Charge Nominale	Capacidad de carga	400 kg
Velocità di sollevamento	Lifting speed	Vitesse de lévage	Velocidad de elevación	10,4 m/min
Massima altezza ancorata	Max anchored height	Hauter max avec ancrages	Altura max con anclajes	120 m
Dimensioni interne cesta	Platform dimensions	Dimensions du plancher	Dimensiones de cabina	1,35 x 0,93 m
Tensione alimentazione	Input power range	Tension d'alimentation	Tensión de red	220/230 V 50/60 Hz 1Ph+1N
Interruttore protezione linea	Protection switch	Interrupteur de protection	Interruptor de protección	16 A
Potenza servizio continuo	Power of the motors	Puissance des moteurs	Potencia de motorreductores	1 x 1,5 kW
Corrente di spunto	Starting current	Ampérage au démarrage	Intensidad de arranque	28 A
Minima potenza di linea consigliata	Minimum line power suggested	Min. puissance de ligne conseillée	Min. potencia linea	3 kW



EHPM 400 MINI MONOFASE
EHM 400 MINI MONOFASE



▲ Compatibile con:
Interchangeability:

- EHM 400mini
- EHM 1000mini
- EHM 500
- EHM 700
- EHPM 400mini
- EHPM 1000mini
- EHPM 500
- EHPM 700

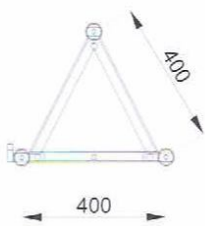

45 kg

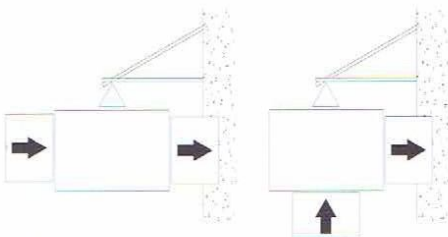

Configurazioni d'accesso possibili
Possible access configurations

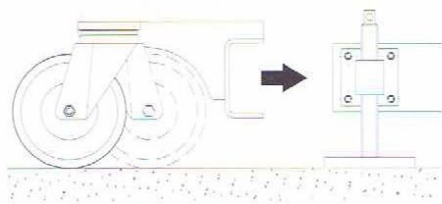

Kit ruote pivotanti
per movimentazione a terra
Rotating wheel kit
for quick positioning

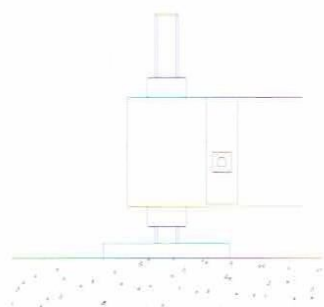

Quattro vitoni di livellamento
Four levelling screw-jacks

